

Horizon

ROTARY DIE-CUTTING

RD Series

Simple, high quality, compact rotary die-cut system.

IMPROVE YOUR DIE-CUTTING PROCESS.

Quick, easy change over and simple operation. Rotary Die-cut System allows flexibility across a wide range of products.

BENEFIT

SPACE SAVING

Rotary Die-cutter designed to meet the growing demand for short run product. The rotary die-cutters are of rugged construction, yet compact compared to the normal die cutters.

APPLICATION FLEXIBILITY

Die-cut and Kiss-cut of various substrates for digital and offset printed sheets.

LABOR SAVING

Feeding, die cutting, and separating are achieved in one pass.

REDUCED DIE COST

Uniquely designed servo motor controlled "Repeat Register" feature allows multiple-up applications from a single-up die to minimize die cost.

SIMPLE AND EASY OPERATION

Reduces costly labor steps and increases productivity with easy setup and operation versus steel rule or mechanical dies.





TWO TYPES OF DIE-CUT SYSTEMS

RD-4055/RD-4055DM

Rotary Die-cut System (Max. 400 x 550 or 15.740" x 21.650")
Die-cut, Crease, Perforation, Slit, Hole punch and round corner in various substrates up to 0.5 mm or 0.019" (only for die cutting).

Dual magnetic system is available as RD-4055DM. Dual magnetic system allows easy operation with male/female dies, especially for creasing applications. It will improve the quality of creasing.



Sheet Feeder FFU-4055 + Rotary Die-Cutter RD-4055 (RD-4055DM)
+ Separator SPC-4055

RD-3346

Rotary Die-cut System (Max. 330.2 x 550 mm or 13" x 21.650")
Repeat function allows processing of 550 mm sheets at maximum. Die-cut and Kiss-cut in various substrates up to 0.3 mm or 0.011".



Rotary Die-Cutter RD-3346 + Separator SPC-3346

DIE-CUTTING MECHANISM.

The sheet passes between the upper die and the lower anvil cylinder to cut.

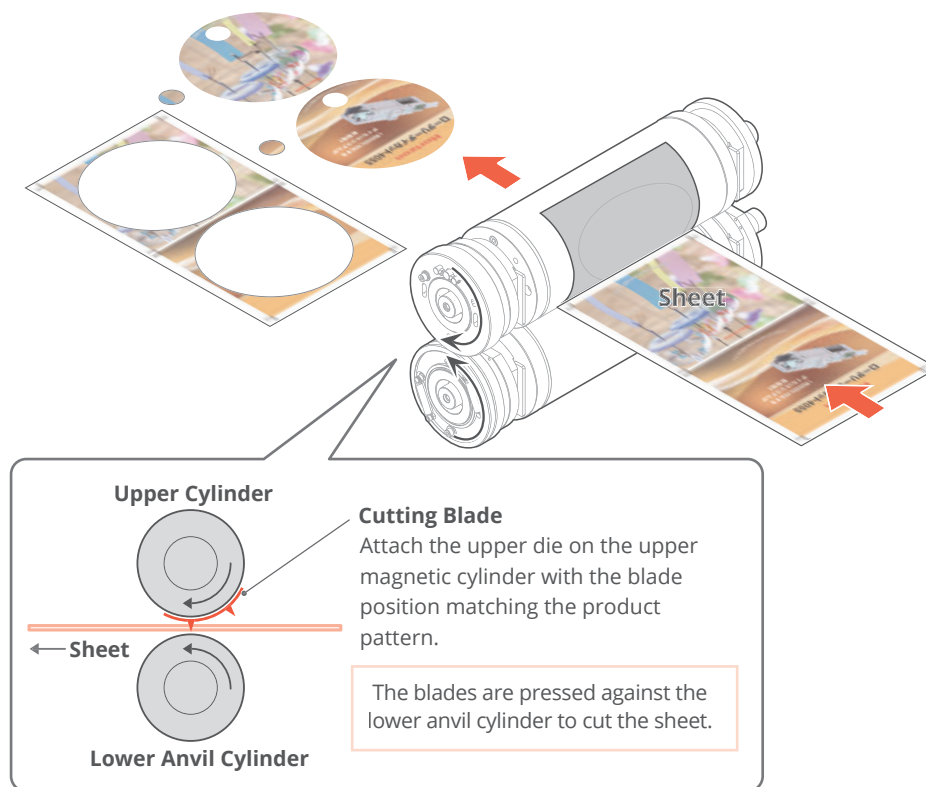

USEFUL FUNCTION

REPEAT FUNCTION

Repeat register function enables the running of multiple up imposed applications with a smaller die to reduce die cost.

(RD-4055 and RD-4055DM: Up to 5 repeats, RD-3346: Up to 8 repeats.)

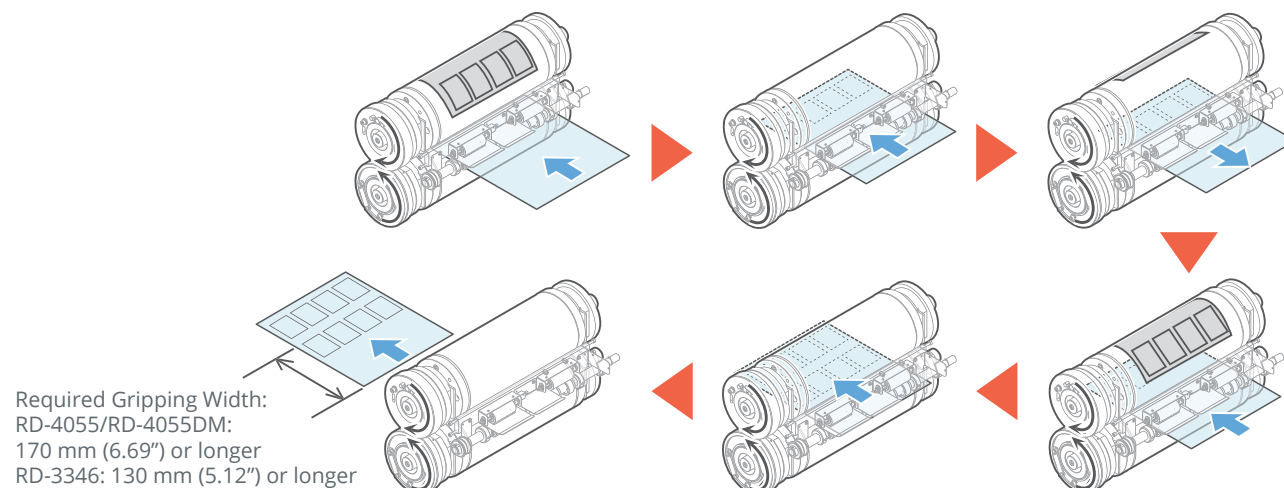

VARIOUS SUBSTRATES.

Rotary Die-cut System is suitable for various types of processing.

KISS CUTTING

Die-cutting and Kiss cutting can be performed at the same time by using a die which has two different blade heights. Ideal for making stickers and labels.

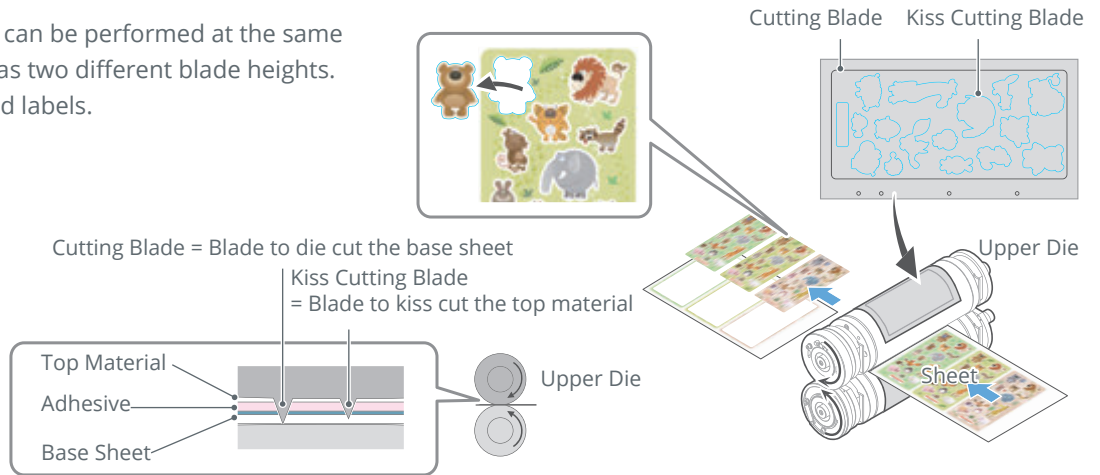

CREASING Only for RD-4055/RD-4055DM

Crease can be achieved to avoid image cracking. Suitable for boxes, pocket folders and greeting cards which require additional folding processes after die cutting.

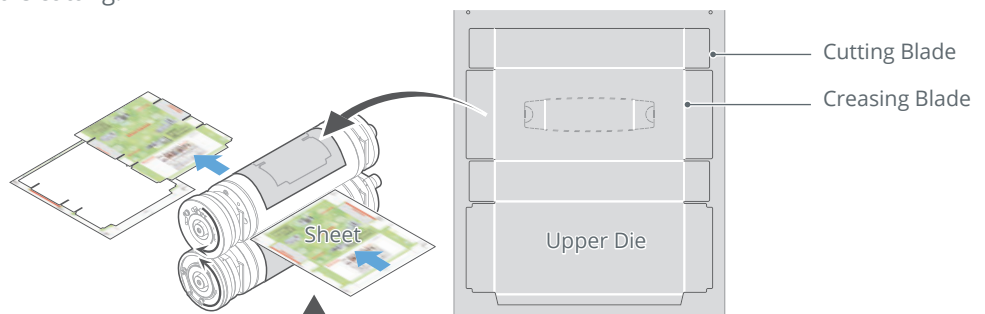
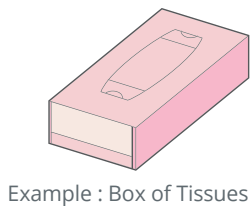

RD-4055

RD-4055DM

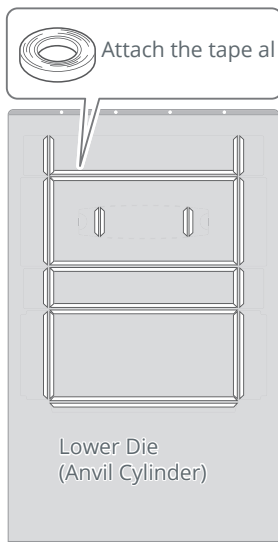
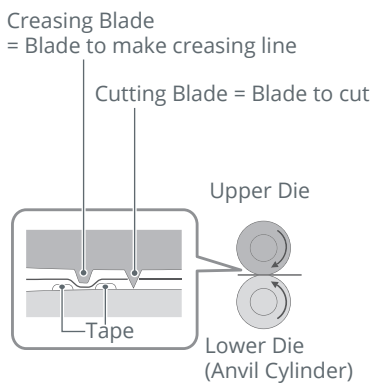

DETAILS FOR EACH DEVICE.

From start to finish.

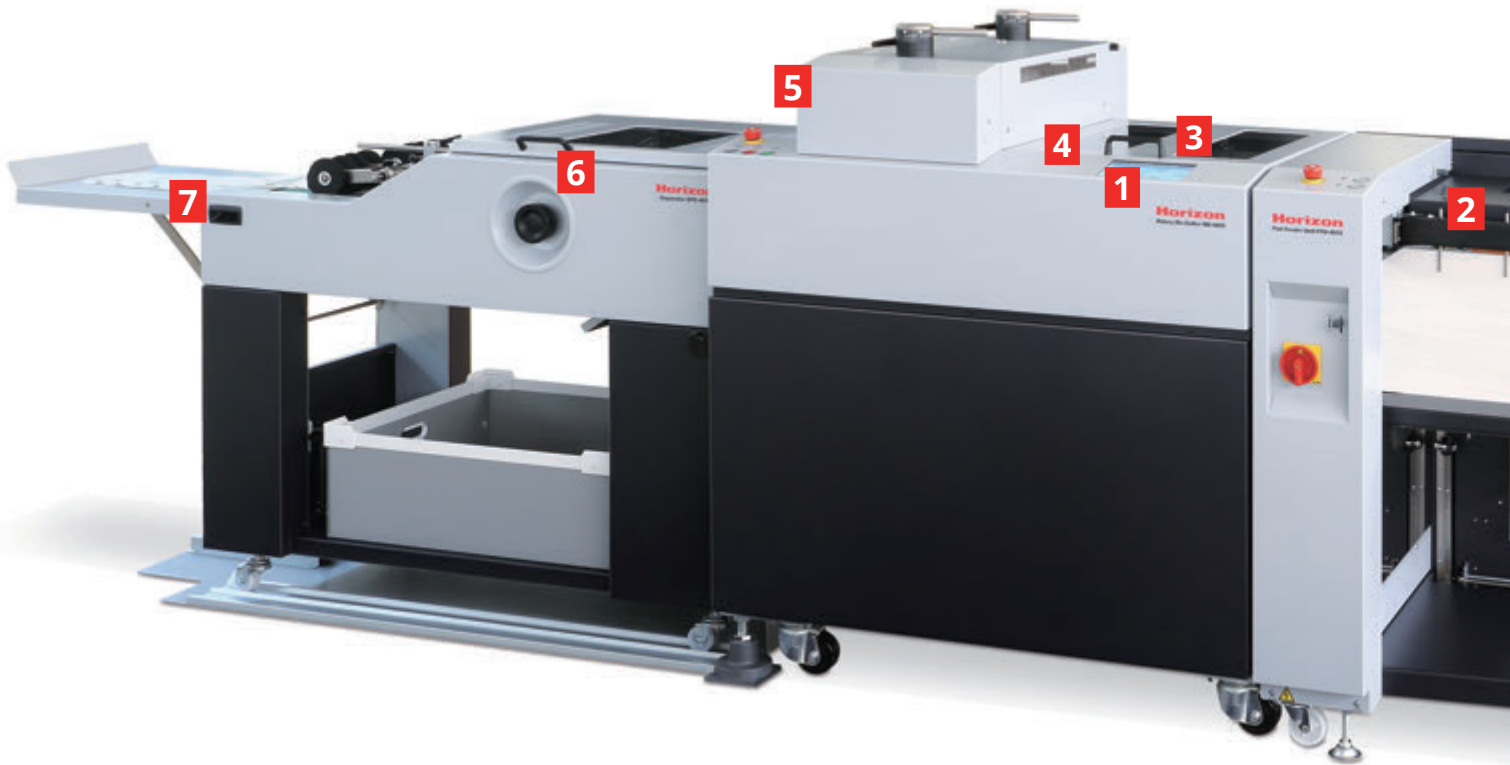

Sheet Feeder FFU-4055 + Rotary Die-Cutter RD-4055 (RD-4055DM) + Separator SPC-4055

1 OPERATION CONSOLE

Both setup and control can be done through the intuitive touch screen. After setting upper and lower die, the system can be set up by simply inputting sheet size and product size. The graphical illustrations on the screen are simple and easy to understand.



3 TRANSPORT SECTION

Sheets are registered by vacuum belt and position is firmly secured with gripper rollers for high quality finish. Servo motor driven gripper rollers ensure the die cut position without effecting processing speed.



2 FEED SECTION

Vacuum belt feeding enables superior feeding with easy setup and operation. An ultrasonic sensor is used for double feed detection on a wide range of substrates.

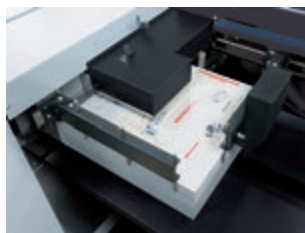

4 MARK SENSOR Option

The optional mark sensor reads the mark printed in the leading margin of sheet. If the printing image is offset, the position is automatically calibrated to process the sheet accurately.



SHEET FLOW OF ROTARY DIE-CUT SYSTEM

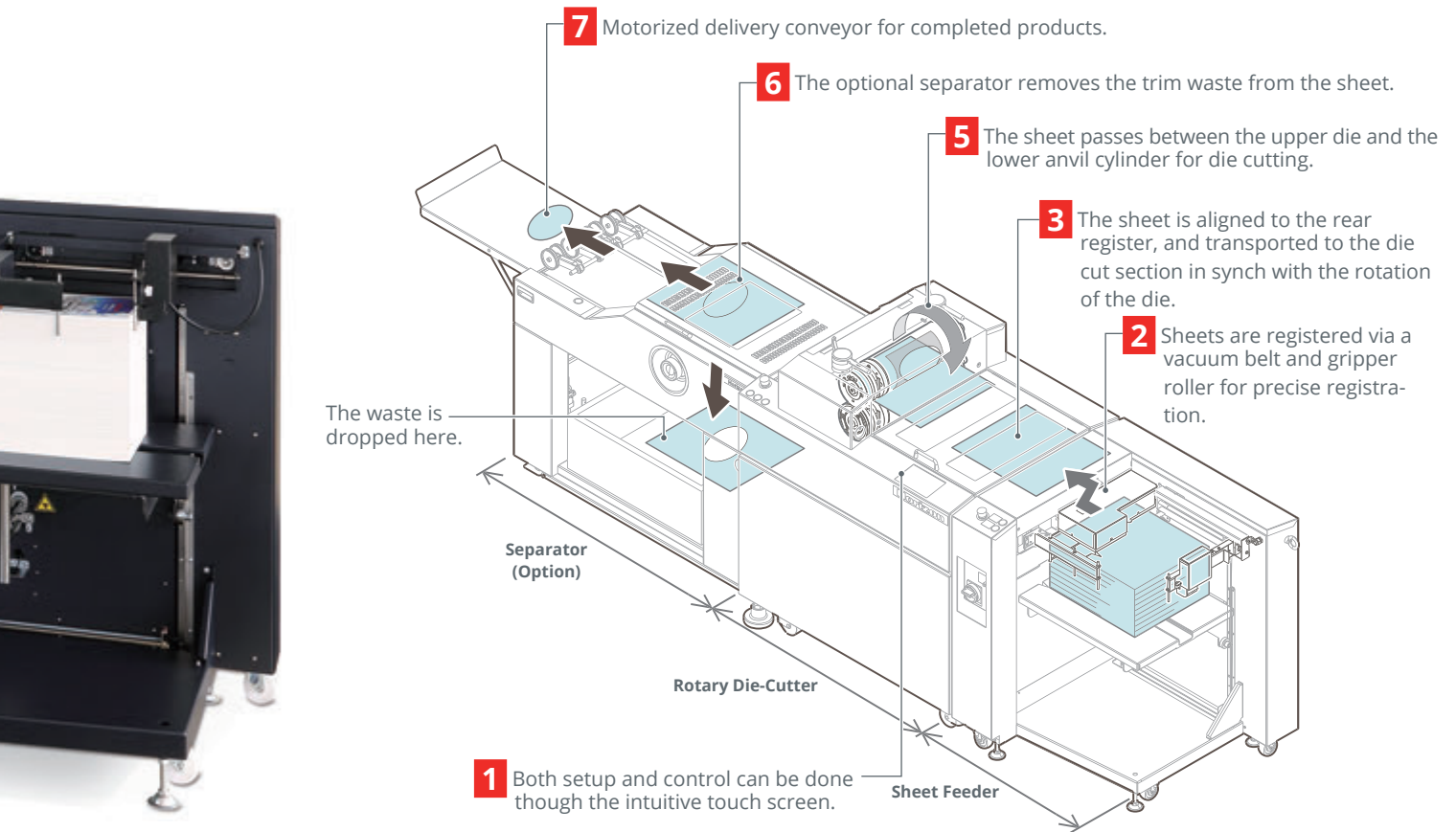

5 DIE CUTTING SECTION

Rigid magnetic upper roller and solid lower anvil cylinder ensure high quality die cutting. Uniquely designed die cutting section enables easy and quick die setting.



6 SEPARATOR **Option**

The connected separator removes the waste from the finished product and delivers it to the waste bin. Air cylinder driven separator pins and air jets can be used depending on size of the waste.



ATTACHING THE LOWER DIE

***Only for RD-4055 / RD-4055DM**

- For RD-4055 and RD-4055DM, the lower die can be attached on the lower cylinder to make crease lines.
- For RD-4055, prepare the lower die by making grooves on the stainless sheet using a tape. The lower die is attached on the anvil cylinder.
- For RD-4055DM, the lower die is attached on the lower magnetic cylinder.



7 DELIVERY SECTION

Supplied with the Separator

Finished products are delivered on the motorized conveyor. Intermittent conveyor movement maximizes the continuous operation in a small space. Gap can be adjusted depending on the size of the product for easy handling.



OPTIONS.

Add-on systems.

ST-4055/STACKER (ONLY FOR RD-4055/RD-4055DM)

- ST-4055 stacks a wider range of substrates and applications such as thinner sheets or complicated shapes which can be difficult to separate.
 - Vacuum belt transport ensures smooth delivery without separating die cut pieces.
 - Offset stacking function is available by pre-set number.
 - Maximum stack capacity: 170 mm or 6.69"
- * To connect the ST-4055, remove the SPC-4055.

VACUUM TRANSPORT SECTION

The vacuum transport belt is decelerated before the stock reaches the backstop for accurate stacking without damage to the die-cut stock.

OPERATION CONSOLE

ST-4055 can be set up by the touch screen at RD-4055/RD-4055DM. Icon based touchscreen ensures intuitive operation.

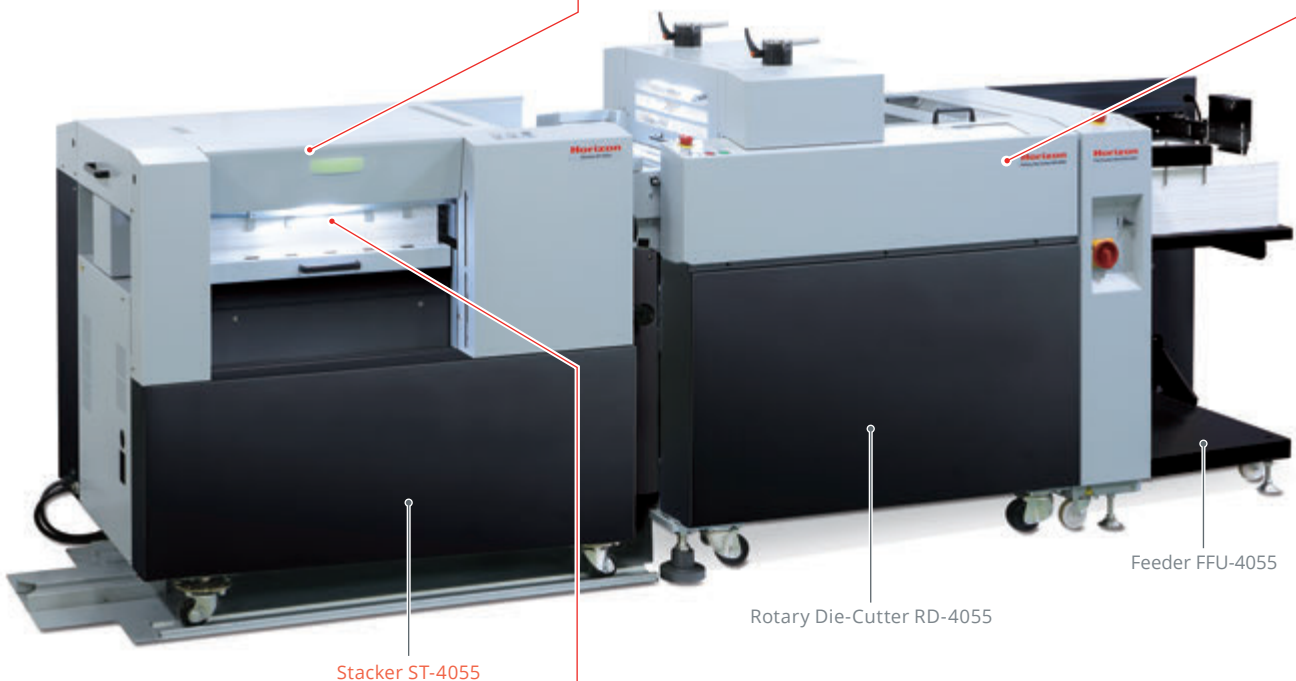

STACK SECTION

Delivery tray slides out for easy removal of finished pile. Offset function is available for easy job handlings.



SPECIFICATION FOR COMPRESSOR WITH ST-4055

Rated Output of Prime Mover (Reference)	0.75 kW
Maximum Operating Pressure	0.8 MPa
Minimum Required Pressure	0.6 MPa or more
Minimum Discharge	85 Liters per minute
Type	Oil-free Type

Prepare the compressor to meet the following specifications:

BT-4055/BUCKET RECEIVING TRAY (ONLY FOR RD-4055/RD-4055DM)

- BT-4055 is bucket receiving tray to deliver none separated die cut sheet in on the receiving tray.



Receiving Tray BT-4055

Rotary Die-Cutter RD-4055

Feeder FFU-4055

SPECIFICATION FOR COMPRESSOR WITH BT-4055

Rated Output of Prime Mover (Reference)	0.2 kW
Maximum Operating Pressure	0.8 MPa
Minimum Required Pressure	0.6 MPa or more
Minimum Discharge	20 Liters per minute
Type	Oil-free Type

Prepare the compressor to meet the following specifications:

LDK-4055 LOWER DIE TOOL KIT

- This kit includes the necessary tools and materials to help for preparing the lower die efficiently.

RD-NP NICK PUNCH

- This optional nick punch is a tool to makes nick on the die easily.

SPECIFICATIONS.

Machine Dimensions. (Unit: mm or inch)

RD-4055/RD-4055DM

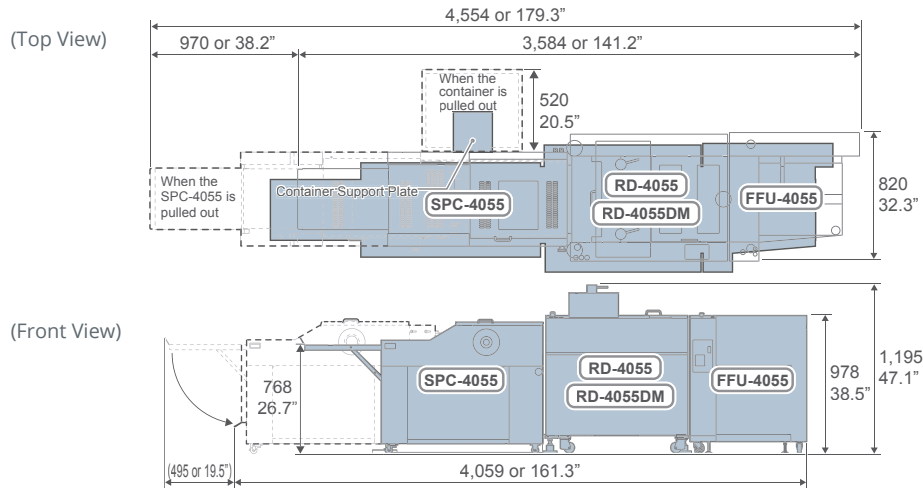

RD-4055/RD-4055DM + BT-4055

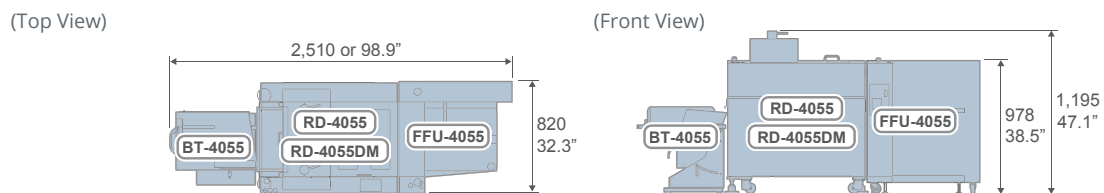

RD-4055/RD-4055DM + ST-4055

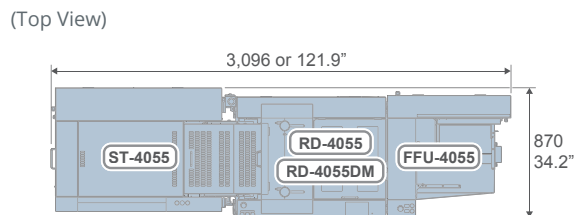

RD-3346

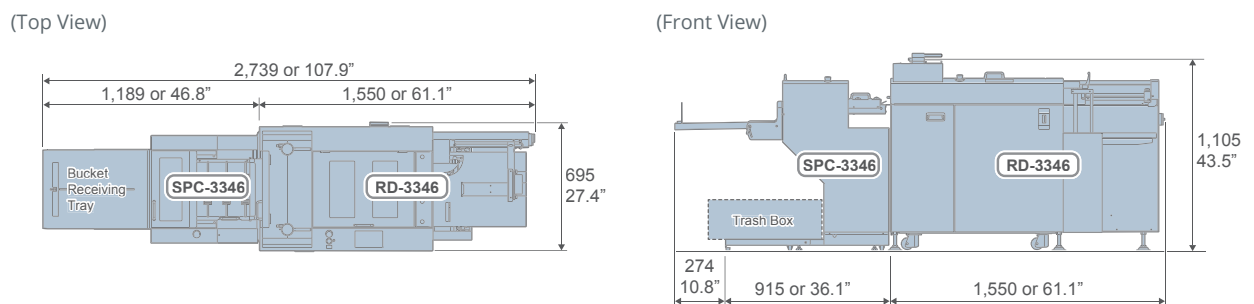

RD-4055/RD-4055DM/RD-3346 SPECIFICATIONS

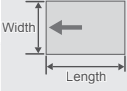
Model	RD-4055	RD-4055DM	RD-3346
Sheet Feeding System	Air Suction Feed Belt		
Sheet Size (Before processing)	 <p>Width x Length Max. 400 x 550 mm or 15.740" x 21.650" Min. 200 x 275 mm or 7.875" x 10.830"</p>		Max. 330.2 x 550 mm or 13" x 21.650" *L400 to 460 mm or 15.745" to 18.11": The production speed is reduced to half. *L460 to 550 mm or 18.11" to 21.650": Repeat die cutting only. Min. 170 x 275 mm or 6.690" x 10.830"
Cut Product Size <i>*The size may be limited depending on shape and sheet weight range.</i>	With separator	<p>Width x Length Max. 376 x 530 mm or 14.803" x 20.866" Min. 50 x 80 mm or 1.969" x 3.15"</p>	With separator Max. 306 x 440 mm or 12.047" x 17.322" Min. 40 x 60 mm or 1.575" x 2.363"
	Without separator (with nicks)	<p>Width x Length Max. 384 x 530 mm or 15.118" x 20.866" Min. Depending on die shape</p>	Without separator (with nicks) Max. 314 x 440 mm or 12.36" x 17.32" Min. Depending on die shape
Processed Material	Normal paper, Coated paper, Cardboard		
Material Thickness	127.9 to 400 gsm Die Cutting: Max. 0.5 mm or 0.019" (In case of blade height: 0.8 mm or 0.031") Max. 0.3 mm or 0.011" (In case of blade height: 0.6 mm or 0.023") Creasing: Max. 0.4 mm or 0.015" (In case of blade height: 0.8 mm or 0.031")	127.9 to 400 gsm Die Cutting: Max. 0.5 mm or 0.019" Creasing: Max. 0.3 mm or 0.011"	127.9 to 270 gsm Max. 0.3 mm or 0.011"
Feeder Stack Height	500 mm or 19.68"		150 mm or 5.90"
Die Size Upper Die	Max. 400 x 560 mm or 15.748" x 22.047" Min. 160 x 100 mm or 6.30" x 3.937"		Max. 330 x 460 mm or 12.99" x 18.11" Min. 160 x 70 mm or 6.30" x 2.76"
Upper Cutting Blade Height	0.6 mm • 0.8 mm or 0.0236" • 0.0315"	0.8 mm or 0.0315"	0.6 mm or 0.0236"
Production Speed	Die cut roller 6,000 cycles per hour (When the ST-4055 is connected, the number of processing sheet is 3,000 sheets per hour.)		Die cut roller 5,000 cycles per hour (If the sheet length is longer than 400 mm or 15.75", the number of processing sheet is limited to 2,500 sheets per hour. When the ST-3346 is connected, the number of processing sheet is limited to 2,500 sheets per hour.)
Voltage/Frequency	Single Phase 200 to 240 V, 50 or 60 Hz Single Phase 230 to 240 V, 50 or 60 Hz (For the machine with CE marking)		Single Phase 200 to 240 V, 50 or 60 Hz
Machine Dimensions	With separator	FFU-4055 + RD-4055 (RD-4055DM) + SPC-4055: W3,584 x D820 x H1,195 mm or W141.2" x D32.3" x H47.1"	With separator W2,739 x D695 x H1,105 mm or W107.9" x D27.4" x H43.5"
	Without separator	FFU-4055 + RD-4055 (RD-4055DM): W2,510 x D820 x 1,195 mm or W98.9" x D32.3" x H47.1"	Without separator W2,150 x D695 x H1,105 mm or W84.7" x D27.4" x H43.5"
Recommended Air Source	When the SPC-4055 / ST-4055 is used Rated Output of Prime Mover(Reference): 0.75 kW Maximum Operating Pressure: 0.95 MPa, 137.7 psi Minimum Required Pressure: 0.55 MPa or more, 79.8 psi or more Minimum Discharge: 85 Liters per minute, 3.01 cfm Type: Oil-free Type When the SPC-4055 is not used Rated Output of Prime Mover: 0.2 kW Maximum Operating Pressure: 0.95 MPa, 137.7 psi Minimum Required Pressure: 0.55 MPa or more, 79.8 psi or more Minimum Discharge: 20 Liters per minute, 0.71 cfm Type: Oil-free Type	When the SPC-4055 or ST-4055 is used Rated Output of Prime Mover (Reference): 0.75 kW Maximum Operating Pressure: 0.8 MPa Minimum Required Pressure: 0.6 MPa or more Minimum Discharge: 85 Liters per minute Type: Oil-free Type When the SPC-4055 is not used, the air source is not required.	Rated Output of Prime Mover (Reference): 0.75 kW Maximum Operating Pressure: 0.8 MPa Minimum Required Pressure: 0.6 MPa or more Minimum Discharge: 85 Liters per minute Type: Oil-free Type

ST-4055 SPECIFICATIONS

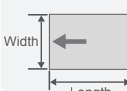
Compatible Machines	RD-4055
Sheet Size	 <p>Width x Length Max. 400 x 550 mm or 15.74" x 21.65" Min. 200 x 275 mm or 7.88" x 10.83"</p>
Sheet Weight Range	Normal Paper, Coated Paper, Cardboard Material Thickness: Max. 0.5 mm or 0.02" 127.9 to 400 gsm
Production Speed	Offset Stacking: 3,000 sheets per hour In the stacking speed reduction mode: 3,000 sheets per hour Straight Stacking without speed reduction mode: 6,000 sheets per hour (This production speed is limited according to the sheet thickness, sheet size, and the number of nicks.)

Stack Capacity	Maximum Stack Height: 170 mm or 6.69" Max Load. 48 kg or 105.8 lb
Voltage/Frequency	Single Phase 200 to 240 V, 50 or 60 Hz
Machine Dimensions	W1,490 x D830 x H1,030 mm or W58.7" x D32.7" x H40.6"
Recommended Air Source	Mover(Reference): 0.75 kW Maximum Operating Pressure: 0.95 MPa, 137.7 psi Minimum Required Pressure: 0.55 MPa or more, 79.8 psi or more Minimum Discharge: 85 Liters per minute, 3.01 cfm Type: Oil-free Type

*The machine design and specifications are subject to change without any notice.

MORE AT
HORIZON.CO.JP



Horizon

Horizon International, Inc.

510 Kuze Ooyabu-cho, Minami-ku,
Kyoto, 601-8206, Japan
Phone : +81-75-934-6700
Fax : +81-75-934-6708
www.horizon.co.jp

Horizon GmbH

Pascalstrasse 20
25451 Quickborn / Germany
Phone : +49 4106 8042-0
Fax : +49 4106 8042-199
www.horizon.de